



## Electric Lift System

- Included in kit: control box (1), memory control switch (1), linear leg units with 6.5' cables (4), 9.5' power cable (1), rubber leveling feet (4), mounting brackets (8), M5 x 8mm bolts (16)
- Kit ships in one box weighing 33 lbs and measuring 30" x 10" x 7" in size



See the lift system in action. Scan the QR code to see a demonstration

### Material Specifications

- Works with 15, 30, 40, 45 series profiles
- Made up of primarily aluminum, plastic and stainless steel
- Max load: 600 kg (1320lbs) – includes weight of frame
- Max stroke: 300mm (11.811")
- Lifting speed: 9mm per second (.354"/sec)
- Retracted Height of legs: 599mm (23.583")
- Extended Height of legs: 899mm (35.394")
- Includes 3 programmable height settings, and a digital readout of current height

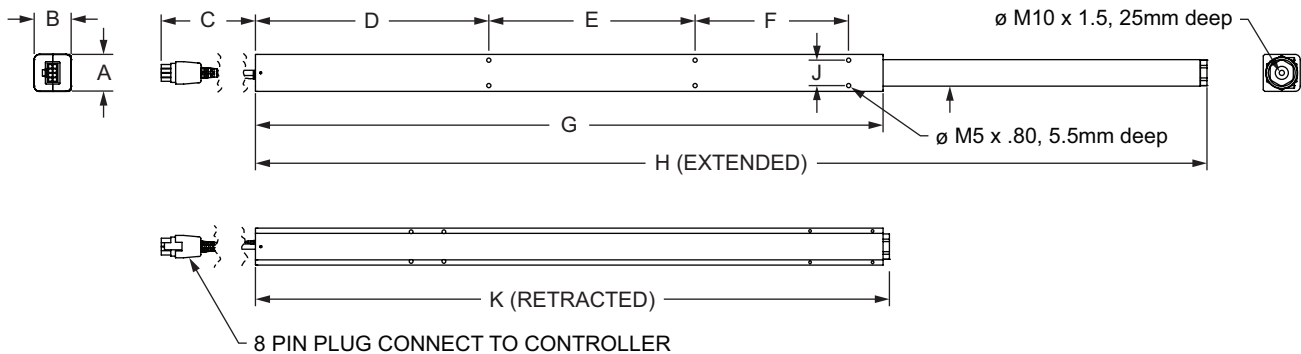

### Linear Leg Unit

| Part No. | Series         | Material         | Color | A                   | B                   | C                     | D                    | E                    | F                    | G                     | H                     | J                  | K                     |
|----------|----------------|------------------|-------|---------------------|---------------------|-----------------------|----------------------|----------------------|----------------------|-----------------------|-----------------------|--------------------|-----------------------|
| 2372     | 15 30<br>40 45 | Aluminum & Steel | Gray  | 1.362"<br>(34.59mm) | 1.378"<br>(35.00mm) | 78.00"<br>(1981.20mm) | 8.665"<br>(220.09mm) | 7.677"<br>(194.99mm) | 5.709"<br>(145.01mm) | 23.346"<br>(592.99mm) | 35.394"<br>(899.01mm) | .945"<br>(24.00mm) | 23.583"<br>(599.01mm) |

Effective Date: 10-25-2022



### Suggested Hardware (Mount Controller or Box to T-Slot)

| Series | Bolt    | Qty. (Controller) | Qty. (Box) | T-Nut | Qty. (Controller) | Qty. (Box) |
|--------|---------|-------------------|------------|-------|-------------------|------------|
| 30     | 11-4310 | 2                 | 3          | 13022 | 2                 | 3          |
| 15 40  | 11-4312 | 2                 | 3          | 13022 | 2                 | 3          |
| 45     | 11-4312 | 2                 | 3          | 13046 | 2                 | 3          |

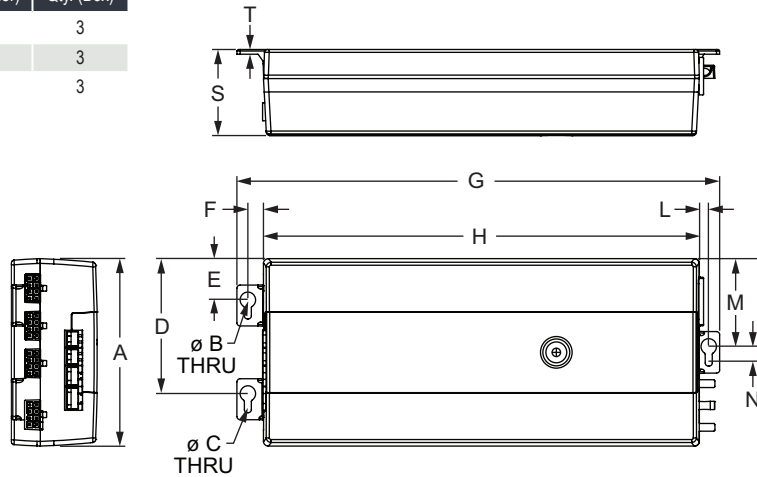
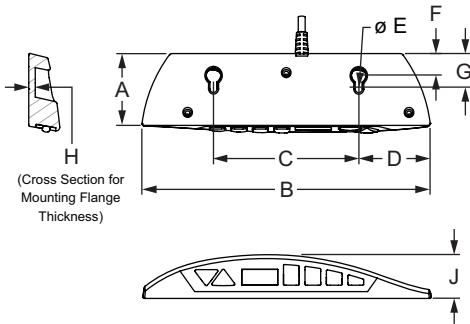

### Memory Controller

| Part No.          | A                   | B                    | C                   | D                   |
|-------------------|---------------------|----------------------|---------------------|---------------------|
| 2372              | 1.800"<br>(45.73mm) | 6.558"<br>(166.58mm) | 3.305"<br>(83.95mm) | 1.625"<br>(41.27mm) |
| E                 | F                   | G                    | H                   | J                   |
| .160"<br>(4.06mm) | .502"<br>(12.76mm)  | .802"<br>(20.38mm)   | .146"<br>(3.69mm)   | .999"<br>(24.48mm)  |

### Controller Box

| Part No.         | A                    | B                  | C                   | D                  | E                   | F                   | G                     | H                     |
|------------------|----------------------|--------------------|---------------------|--------------------|---------------------|---------------------|-----------------------|-----------------------|
| 2372             | 4.724"<br>(119.99mm) | .394"<br>(10.01mm) | .157"<br>(3.99mm)   | 3.40"<br>(86.36mm) | 1.039"<br>(26.39mm) | .394"<br>(10.01mm)  | 12.169"<br>(309.09mm) | 10.988"<br>(279.09mm) |
| J                | K                    | L                  | M                   | N                  | R                   | S                   | T                     |                       |
| .22"<br>(5.59mm) | 3.602"<br>(91.49mm)  | .240"<br>(6.09mm)  | 2.213"<br>(56.21mm) | .416"<br>(10.57mm) | 2.347"<br>(59.61mm) | 2.166"<br>(55.02mm) | .118"<br>(2.99mm)     |                       |

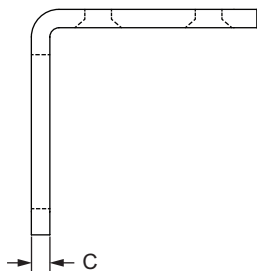

### Included Hardware

| Bolt           | Qty. |
|----------------|------|
| M5 x 8mm FHSCS | 16   |

### Suggested Hardware (Mount to T-Slot)

| Series | Bolt    | Qty. | Washer  | Qty. | T-Nut | Qty. |
|--------|---------|------|---------|------|-------|------|
| 30     | 11-8312 | 8    | 11-6042 | 8    | 13094 | 8    |
| 15 40  | 11-8316 | 8    | 11-6042 | 8    | 3838  | 8    |
| 45     | 11-8316 | 8    | 11-6042 | 8    | 13062 | 8    |

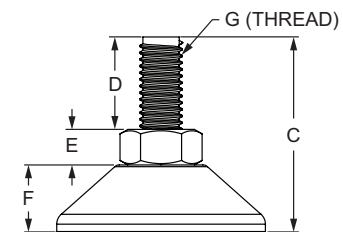
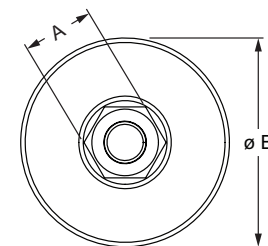
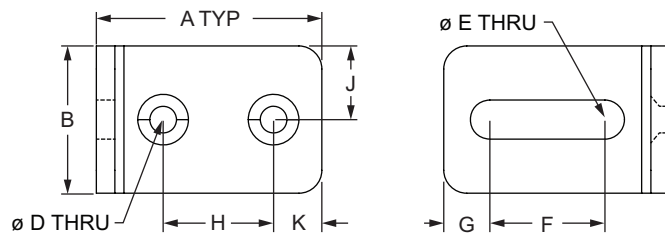

### Mounting Bracket

| Part No. | Material | Color | A                   | B                   | C                  | D                  | E                  |
|----------|----------|-------|---------------------|---------------------|--------------------|--------------------|--------------------|
| 2372     | Steel    | Gray  | 1.929"<br>(48.99mm) | 1.260"<br>(32.00mm) | .157"<br>(3.99mm)  | .228"<br>(5.80mm)  | .335"<br>(8.50mm)  |
|          |          |       | F                   | G                   | H                  | J                  | K                  |
|          |          |       | .984"<br>(24.99mm)  | .394"<br>(10.00mm)  | .945"<br>(24.00mm) | .630"<br>(16.00mm) | .413"<br>(10.50mm) |

### Rubber Leveling Feet

| Part No.           | A                  | B                   | C                   |
|--------------------|--------------------|---------------------|---------------------|
| 2372               | .630"<br>(16.00mm) | 1.850"<br>(46.99mm) | 1.725"<br>(43.82mm) |
| D                  | E                  | F                   | G                   |
| .819"<br>(20.80mm) | .315"<br>(8.00mm)  | .591"<br>(15.01mm)  | M10 x 1.5           |

Effective Date: 10-25-2022